

Main location of decals For the mid-section interior

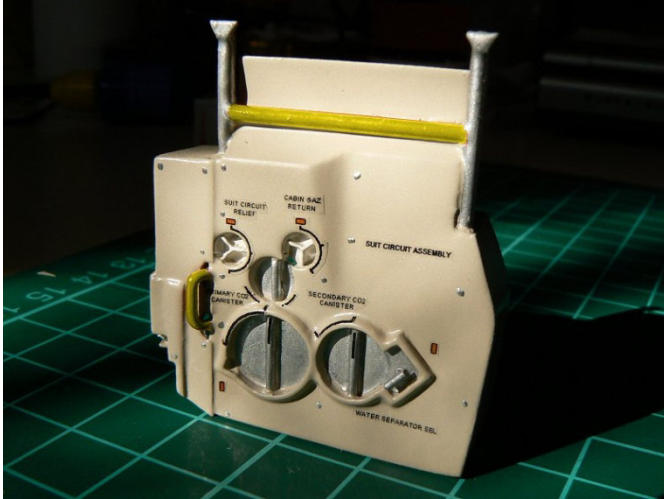

Decals on the Environmental Control System

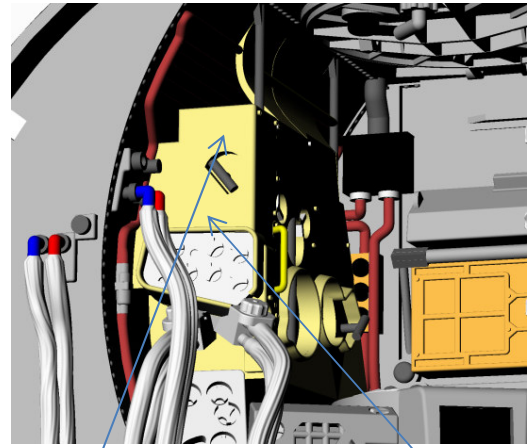

SUIT GAS
DIVERTER

OXYGEN CONTROL MODULE

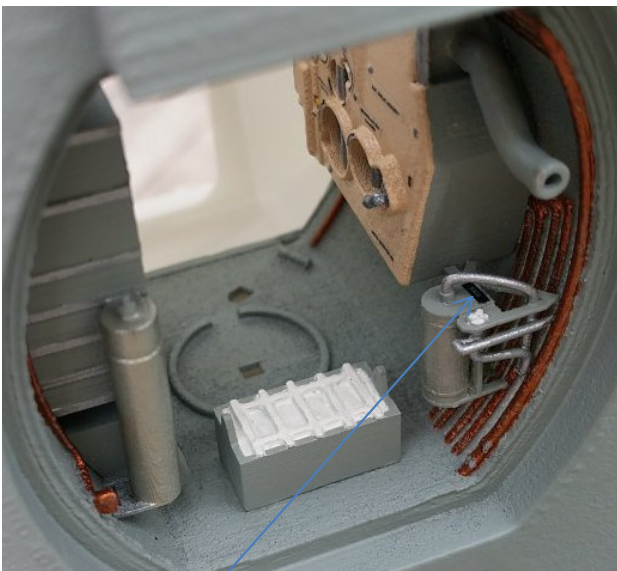

DESCENT COOLING



Decals on the mid-section back wall (Apollo 11 only)
PLSS REMOTE CONTROL UNITS

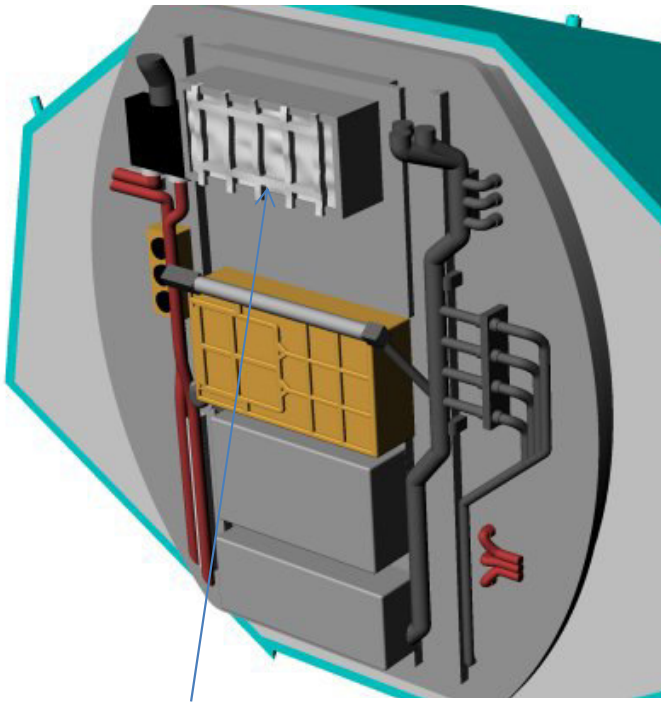

FOOD CONTAINER

H2O BACT FILT

LUNAR OVERSHOES

FLIGHT DATA FILE

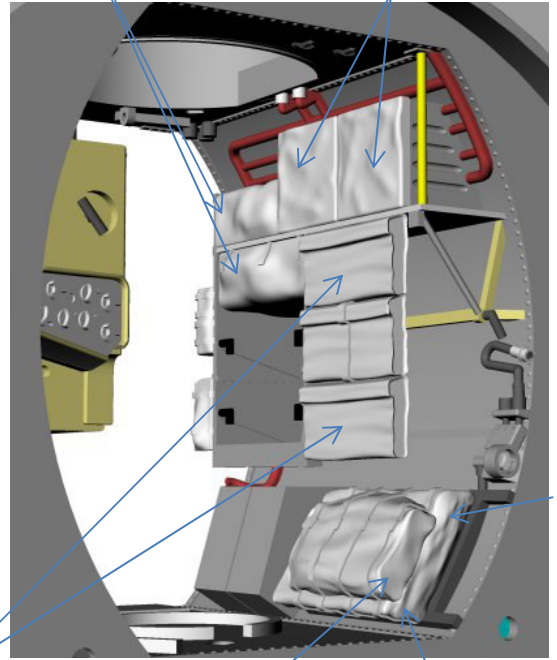

ECGS

IN FLIGHT
COVERALLS

COSMIC RAY
DETECTOR

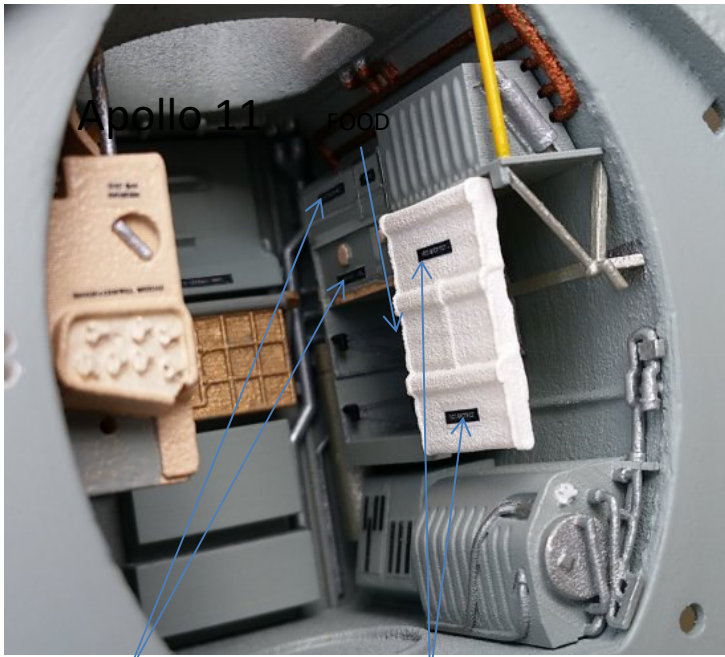

Apollo 11 FOOD

LUNAR OVERSHOES

H2O BACT FILT

PLSS
DOWNING

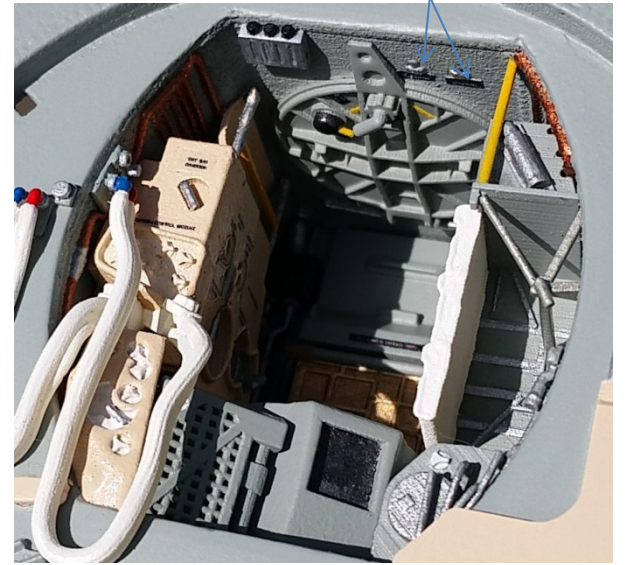

Upper hatch

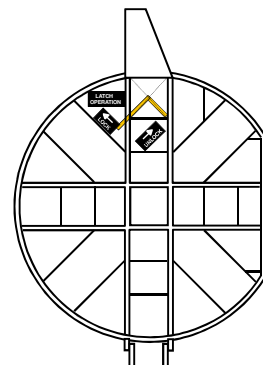

SUITGAS
SWITCHES
ORIGIN CONTROL MODULE

ECS

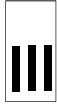

1/24 decals to be printed on white decal paper

PLSS REMOTE CONTROL UNIT

PLSS remote control
Units

LINEAR OVERSHOOT	ROCKET COOLING	GLIDE ATTITUDE ROLL	ELECTRICAL AIRFLOW KEY	WIND BATTERY
LINEAR OVERSHOOT	ROCKET COOLING	ROCKET COOLING	WIND BATTERY	WIND BATTERY
FOOD	FOOD	FOOD	IN FLIGHT OPERATION	ROCKET KEY DETECTOR
PIU DOWNING	ROCKET DATA FILE	R.F.K.	IN FLIGHT OPERATION	
PIU DOWNING	DIPSWAL CONTAINER	CONDUCTOR	IN FLIGHT OPERATION	
PIU DOWNING	LEAKY CAMERA COVER	STROBE	IN FLIGHT OPERATION	
PIU DOWNING		STROBE	IN FLIGHT OPERATION	
PIU DOWNING		STROBE	IN FLIGHT OPERATION	
PIU DOWNING		STROBE	IN FLIGHT OPERATION	



Various markings

1/32 decals to be printed on white decal paper

PLSS remote control
Units



Various markings

